

**TECHNICAL DATA - TECHNISCHE DATEN - DATI TECNICI
DONNÉES TECHNIQUES - DATOS TECNICOS**

M038

1) TOOL TYPE - GERAETETYP - DESCRIZIONE MACCHINA - TYPE D'OUTIL - TIPO DE MAQUINA
cod. 11073 - 21073 - 31073 - U31073 1B 80-16

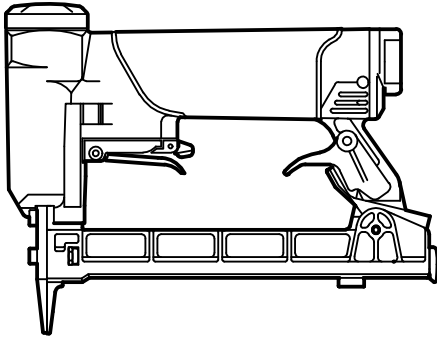

2) TOOL CHARACTERISTICS
SPECIFICATION DES GERAETES
CARATTERISTICHE TECNICHE
CARACTÉRISTIQUES DE L'OUTIL
CARACTERÍSTICAS DE LA MAQUINA

HEIGHT HOEHE ALTEZZA HAUTEUR ALTURA	WIDTH BREITE LARGHEZZA LARGUEUR ANCHURA	LENGTH LAENGE LUNGHEZZA LONGUEUR LONGITUD	WEIGHT GEWICHT PESO POIDS PESO
in.6.18 mm.157	in.1.65 mm.42	in.8.58 mm.218	lbs.1.71 kg.0.780
MIN-MAX WORKING PRESSURE MIN-MAX ARBEITSDRUCK MIN-MAX PRESSIONE DI ESERCIZIO MIN-MAX PRESSION DE TRAVAIL MIN-MAX PRESION DE TRABAJO		60 / 100 PSIG 4 / 7 BAR	
AIR CONSUMPTION PER SHOT LUFTVERBRAUCH PRO NAGELUNG CONSUMO ARIA PER COLPO CONSOMMATION DE L'AIRE PAR COUP CONSUMO DE AIRE CADA DISPARO		PERFORMANCES AT 90 psi (0.62 MPa) PRESTAZIONI A 6.2 bar (0.62 MPa) 0.37 l.	
LUBRICANT SCHMIEROEL LUBRIFICANTE LUBRIFIANT LUBRIFICANTE		AEROSPACE LUBRICANTS TRIBOLUBE 12	

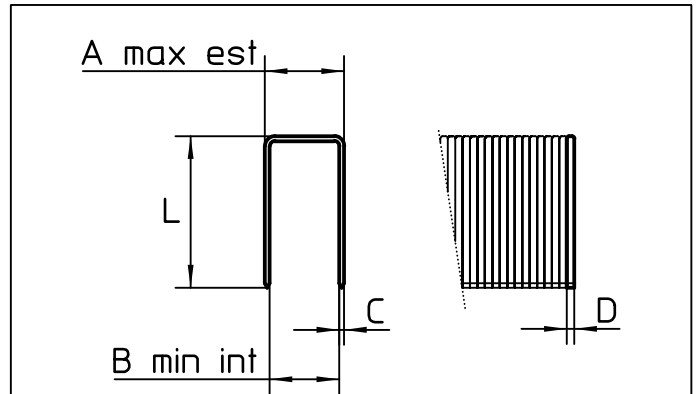

3) FASTENER DATA
ANGABEN ZU DEN BEFESTIGUNGSMITTELN
CARATTERISTICHE TECNICHE FISSAGGI
DONNÉES DES PROJECTILES
DATOS DE CLAVOS

A) OUTSIDE CROWN AUSSEN RUECKEN LARGHEZZA EST. COURONNE EXT. CORONA EXT.	} MAX	in. 0.503 mm. 12.80
B) INSIDE CROWN INNEN RUECKEN LARGHEZZA INT. COURONNE INT. CORONA INT.		} MIN
CxD) WIRE DRAHT FILO FIL ALAMBRE		
L) LENGTH LAENGE LUNGHEZZA LONGUEUR LONGITUD	} MIN-MAX	in. 1/4' - 5/8' mm. 6 - 16
MAGAZINE CAPACITY MAGAZIN CAPAZITAET CAPACITA' CARICATORE CAPACITE' CHARGEUR CAPACIDAD CARGADOR		

* ACTUATION SYSTEM * AUSLÖSEART * ATTUAZIONE * MISE EN ŒUVRE * ACTUACIÓN	1 (SAFETY : MANUAL)
--	----------------------------

* LOADING	<input checked="" type="radio"/> BOTTOM LOADING
* LADEN	SIDE LOADING
* CARICAMENTO	TOP LOADING
* CHARGER	COIL
* CARGA	OTHER

* SEE INSTRUCTION MANUAL - SIEHE BETRIEBSANLEITUNG - VEDI MANUALE - VOIR MODE D'EMPLOI - VER EL MANUAL

NOISE CHARACTERISTICS GERÄUSCH - EMISSION DATEN CARATTERISTICHE RUMOROSITÀ CARACTÉRISTIQUES ACOUSTIQUE CARACTERÍSTICAS DE RUIDO	} EN 12549+A1:2008	$L_{WA,1s}$, : 92.12 dB(A) - $K_{WA,1s}$, 2.5
		} EN ISO 4871:2009

VIBRATION VALUE VIBRATIONSWERT VALORE DI VIBRAZIONE VALEUR DE VIBRATION VALOR DE VIBRACIÓN	} UNI ISO/TS 8662-11	IS BELOW THE DECLARATION LIMIT SET BY LIEGT UNTER DEM ANZUGEBENEN WERT GEMÄSS RISULTA AL DI SOTTO DEL LIMITE DA DICHI. STABILITO IN RESULTE AU DESSOUS DE LA LIMITE A DECLARER ETABLIE PAR RESULTA SER DEBAJO DEL LIMITE A DECLARAR	} UNI EN ISO 12100-1/2